

Article number: 0102228

Description: Retaining ring J500 DIN472
Spring steel

Measures

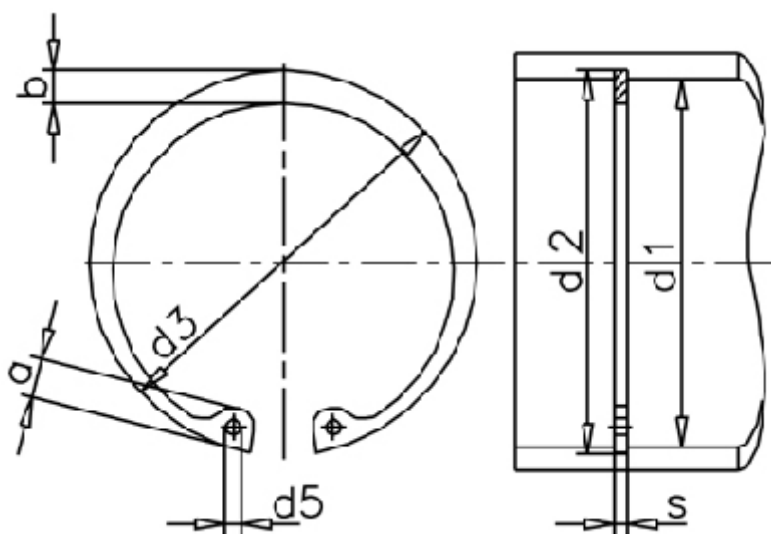

a max	=	FN kN	= 1588.00	t	= 6.00
AN mm ²	= 9530.0	FRg kN	= 125.0	tol	= +1,00
b	= 26.0	FR kN	= 1256.0	tol	= +3,00-1,50
d1	= 500	g	= 6.0	tol	= -0.15
d2	= 512.0	K kN-mm	= 2878.0	Tong	= ZGJ-5
d3	= 520.00	m min	= 7.20	Weight kg/1000	= 1730.00
d5 min	= 6.0	Nominal drive	= 18.0		
Description = J 500		s	= 7.00		